

KENWOOD

FM/AM CD RECEIVER

KDC-5000

FILE

INSTRUCTION MANUAL

KENWOOD CORPORATION



Take the time to read through this instruction manual. Familiarity with installation and operation procedures will help you obtain the best performance from your new FM/AM CD receiver.

For your records

Record the serial number, found on the back of the unit, in the spaces designated on the warranty card, and in the space provided below. Refer to the model and serial numbers whenever you call upon your KENWOOD dealer for information or service on the product.

Model KDC-5000 Serial number _____

OM-693-00

©PRINTED IN JAPAN B64-0290-08 (K) (MC)

WARNING

▲ CAUTION

The use of optical instruments with this product will increase eye hazard.

INFORMATION

This equipment generates and uses radio frequency energy and if not installed and used properly, that is, in strict accordance with the manufacturer's instructions, may cause interference to radio and television reception. It has been type tested and found to comply with the limits for a Class B computing device in accordance with the specifications in Subpart J of Part 15 of FCC Rules, which are designed to provide reasonable protection against such interference in a residential installation. However, there is no guarantee that interference will not occur in a particular installation. If this equipment does cause interference to radio or television reception, which can be determined by turning the equipment off and on, the user is encouraged to try to correct the interference by one or more of the following measures:

- Reorient the receiving antenna
- Relocate this equipment with respect to the receiver
- Move this equipment away from the receiver
- Plug this equipment into a different outlet so that equipment and receiver are on different branch circuits.

If necessary, the user should consult the dealer or an experienced radio/television technician for additional suggestions. The user may find the following booklet prepared by the Federal Communications Commission helpful:

"How to Identify and Resolve Radio-TV Interference Problems".

This booklet is available from the U.S. Government Printing Office, Washington, DC 20402, Stock No. 004-000-00345-4.

- AS the laser beam used in this compact disc player is harmful to the eyes, do not attempt to disassemble the cabinet. Refer servicing to qualified personnel only.

FCC WARNING

This equipment may generate or use radio frequency energy. Changes or modifications to this equipment may cause harmful interference unless the modifications are expressly approved in the instruction manual. The user could lose the authority to operate this equipment if an unauthorized change or modification is made.

NOTE

This equipment has been tested and found to comply with the limits for a Class B digital device, pursuant to Part 15 of the FCC Rules. These limits are designed to provide reasonable protection against harmful interference in a residential installation. This equipment may cause harmful interference to radio communications, if it is not installed and used in accordance with the instructions. However, there is no guarantee that interference will not occur in a particular installation. If this equipment does cause harmful interference to radio or television reception, which can be determined by turning the equipment off and on, the user is encouraged to try to correct the interference by one or more of the following measures:

- Reorient or relocate the receiving antenna.
- Increase the separation between the equipment and receiver.
- Connect the equipment into an outlet on a circuit different from that to which the receiver is connected.
- Consult the dealer or an experienced radio/TV technician for help.

SAFETY PRECAUTIONS

▲WARNING

To prevent fire and avoid personal injury in case of accidents

- When extending the power supply, memory backup or ground lead, avoid short circuits by using 0.75mm² (AWG 18) or larger automotive grade cable.
- Check to be sure that no metal objects (tools, needles, coins) are left inside the unit.
- If you smell or see smoke, disconnect the unit immediately and consult your KENWOOD dealer. Continued use can cause a fire or permanent damage to the unit.

▲CAUTION

To keep the unit in proper working order

- Be sure it's connected to a 12V DC power supply with a minus ground connection.
- Do not open front panel or top or bottom cover.
- Do not expose this unit to direct sunlight or high heat.
- Keep it clean and dry.
- Be sure it is fastened securely and not exposed to excess vibration.

NOTE

- If you have difficulty in installing this unit in your vehicle, please contact your KENWOOD dealer.
- If it doesn't seem to be working properly, first press the Reset button. If the malfunction persists, consult your KENWOOD dealer.

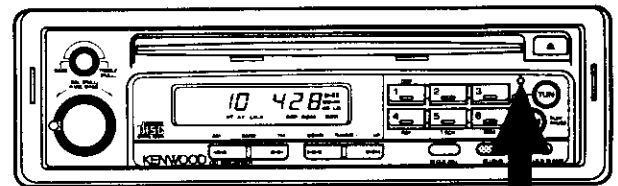

Reset button

CARE AND MAINTENANCE

Cleaning

1. Always turn the power OFF before cleaning.
2. Wipe the front panel and other exterior surfaces with a soft dry cloth or a soft cloth lightly moistened with a neutral detergent.

▲ CAUTION

- DO NOT use abrasive pads or paint thinner, benzene, or other volatile solvents. These may remove the indicator characters.

CD slot cleaning

Since dust accumulates in the CD slot, it will sometimes need to be cleaned. Discs loaded in dusty slots may be damaged.

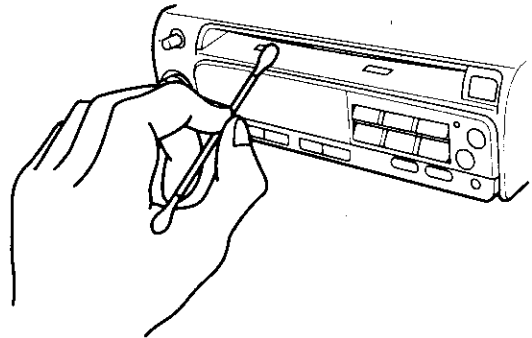

LENS FOGGING AND HEAT PROTECTION

Lens Fogging

- In cold climates, there may be a period after you turn on your vehicle's heater when the lens that guides the laser beam used in your CD player fogs up. If this happens, your CD player will not work properly. If you wait about an hour, the fogging will disappear and your CD player will work normally.
If it does not return to normal, please contact your KENWOOD dealer or authorized service center.

Heat Protection

- In warm climates, when vehicles are left standing in direct sunlight with the windows closed, the temperature inside can rise above 60°C. Your CD player's protection circuits will then display the message "HOLD" and prevent the player from operating. Just open the windows or turn on the air conditioning. As soon as the "HOLD" message disappears, the player will operate normally.
If it does not return to normal, press Reset button before use.

HANDLING COMPACT DISCS

- Stains, dust, scratches or warping can cause skipping or other malfunctions. To enjoy your discs for a long time, please handle them as follows.

<Holding a Disc>

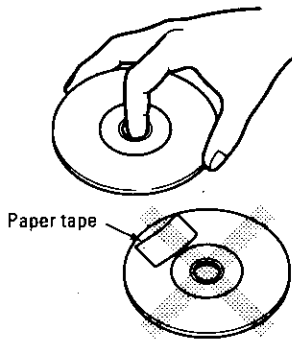

- Avoid touching the music storage area (the part with the glistening rainbow colors).
- Do not use paper tape on the label or music storage area.

<Storing Your Discs>

- Do not store discs where they will be exposed to direct sunlight, high heat, or humidity.
- Especially in summer, never leave your discs exposed to sunlight on the dashboard or on the seat with the windows closed. High heat can cause warping.
- If you do not use your player for an extended period of time, remove the disc magazine from the changer and store it in a cool, dry place.
- Store your discs in their cases or in the magazine. To avoid scratches, dirt, or warping, do not leave them lying around without cases, piled up, or leaning on each other.

<Cleaning Your Discs>

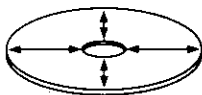

- If there are fingerprints or stains on a disc, wipe them off with a soft cotton cloth, wiping from the center to the outside edge. Never use paint thinner, benzene or conventional record cleaners.

<Check Your New Discs>

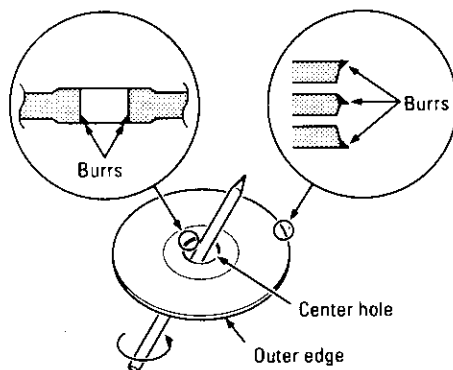

- Some new discs have burrs on their outer edges or around the hole in the center. Use a ballpoint pen or similar instrument to remove them. Discs with burrs may not fit properly in the player or disc magazine, causing skipping when they are played.

<Disc Accessories>

- There are several types of stabilizers, protective seals, and other disc accessories on the market, which claim to offer improved sound quality or disc protection. These accessories can, however, change the dimensions or thickness of a disk and may cause the disc changer to malfunction. They should not be used on discs played in this unit.

	Page
■ Before you begin	
FEATURES	8
■ Your new CD Radio	
ON/OFF,VOLUME,BALANCE&BASS/TREBLE CONTROLS.....	9
INTENSITY	10
AUTO SEEK TUNING	11
MANUAL TUNING	12
LOCAL SCAN	13
TO PLAY COMPACT DISCS	14
■ Tuner features	
PRESET STATIONS	16
AUTO MEMORY	17
■ CD player features	
TRACK SEARCH	18
TRACK REPEAT.....	19
TRACK SCAN	20
RANDOM PLAY	21
■ Convenient features	
CLOCK DISPLAYS / SETTING	22
CHANNEL BAND SELECTION	23
■ Installation	
ACCESSORIES.....	24
INSTALLATION PROCEDURE	25
CONNECTIONS	26
INSTALLATION.....	27
■ TROUBLESHOOTING	29
■ SPECIFICATIONS	30

FEATURES

■ TUNER FEATURES

- **Auto seek tuning (p.11)**
Automatically searches for stations you can receive.
- **Local scan (p.13)**
When this feature is turned on, it combines scanning and Auto Memory and presets only strong stations offering good reception.
- **Preset stations (p.16)**
Stores the frequencies of your favorite stations in memory, for one-touch tuning.
- **Auto memory (p.17)**
Automatically stores the strongest stations you can pick up, for one-touch tuning.

■ CD PLAYER FEATURES

- **Track repeat (p.19)**
Plays the same track repeatedly.
- **Track scan (p.20)**
Automatically plays the first part of each track on the disc in sequence, to help you find the one you want.
- **Random play (p.21)**
Plays the tracks on a CD in random order.

■ CONVENIENT FEATURES

- **Clock display (p.22)**
Displays the time in the display window.
- **Channel band selection (p.23)**
Allows you to switch bands between FM:200kHz/AM:10kHz and FM:50kHz/AM:9kHz.

ON/OFF, VOLUME, BALANCE & BASS/TREBLE CONTROLS

POWER ON/OFF

To turn the power ON

- ▶ Press the Power button.
(Tuner reception will begin.)

To turn the power OFF

- ▶ Press the Power button for more than one second.

BASS & TREBLE

Weaker



Stronger

BASS

Weaker



Stronger

Pull

TREBLE

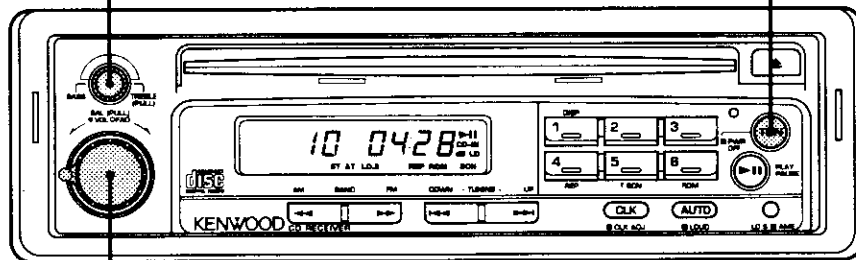

VOLUME/BALANCE/FADER

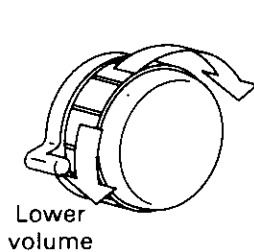

Increase volume

Lower volume

VOLUME

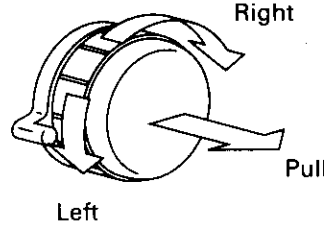

Right

Left

Pull

BALANCE

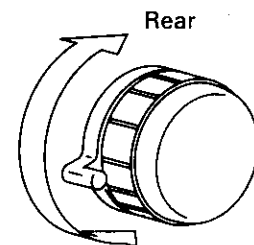

Rear

Front

FADER

NOTE

- Perform these operations with the power ON.

INTENSITY

- ▶ If the Loud indicator light is not illuminated, press the Loud button for more than one second. (Loud indicator light will light up. Bass volume increases.)

F 1 9 2 1 

ON

TO RESTORE ORIGINAL LEVELS

- ▶ Press the Loud button again for more than one second. (Loud indicator light will go out.)

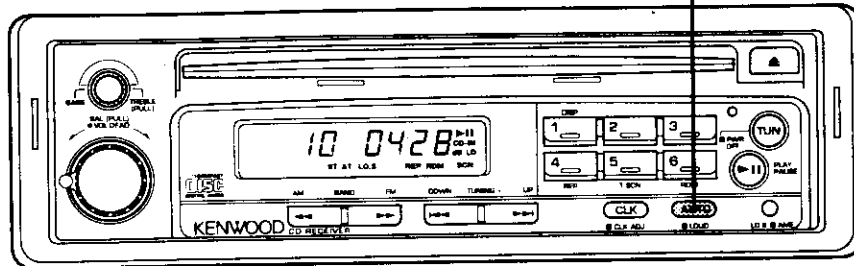

AUTO SEEK TUNING

1

To select an FM band

- ▶ Press the FM button to choose FM1 or FM2.

To select an AM band

- ▶ Press the AM button.

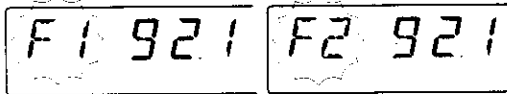

FM1

FM2

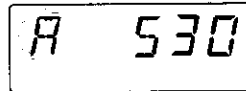

AM

2

- ▶ If the Auto indicator light is not illuminated, briefly press the Auto button to turn the Auto function on. (The Auto indicator light will light up.)

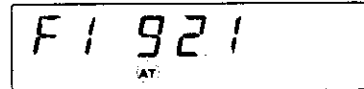

ON

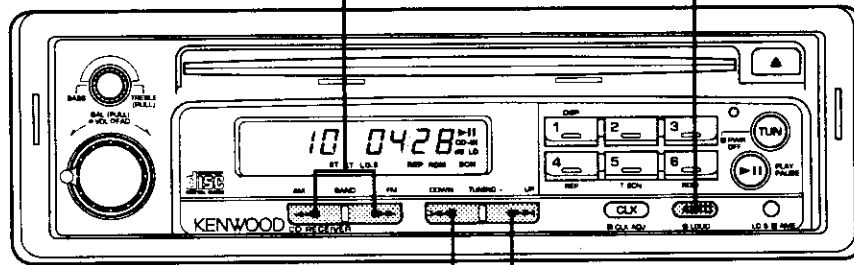

3

- ▶ Press either the Down seek or the Up seek button. (The Auto seek function will find the next station you can receive.)



DOWN SEEK UP SEEK

Illuminated when FM stereo broadcasts are received.



Display shows frequency of station received.

MANUAL TUNING

1

To select an FM band

- ▶ Press the FM button to choose FM1 or FM2.

To select an AM band

- ▶ Press the AM button.

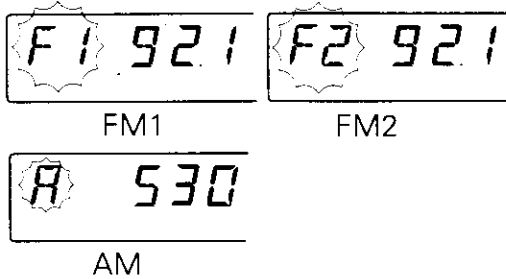

2

- ▶ If the Auto indicator light is illuminated, briefly press the Auto button to turn the Auto function off. (The indicator light will go out.)

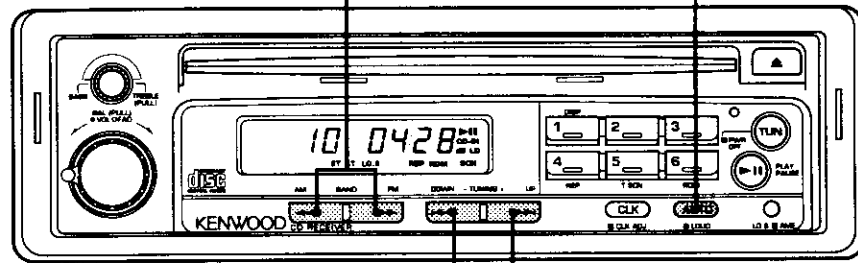
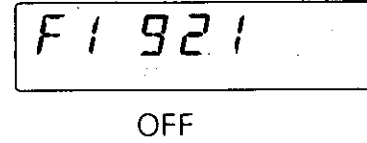

3

- ▶ Press either the down or up arrow button. (The frequency will continue to change as long as you hold the button down.)

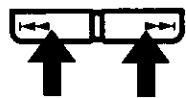

DOWN: for lower frequencies

UP: for higher frequencies

Illuminated when FM stereo broadcasts are received.

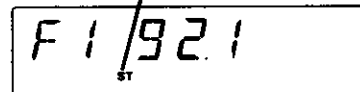

Display shows frequency of station received.

1

To turn on Local scan

- ▶ Briefly press the Local scan button.
(The indicator light will light up.)



ON

2

To turn off Local scan

- ▶ Briefly press the Local scan button again.
(The indicator light will go out.)

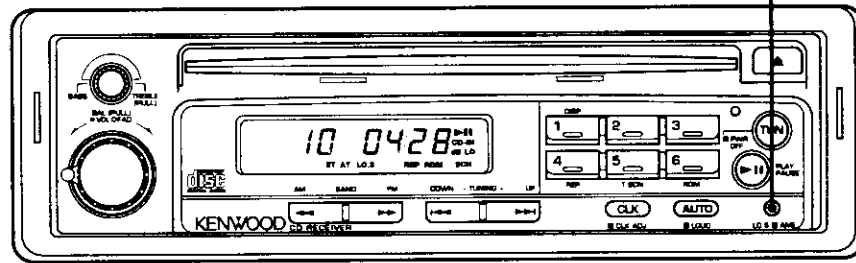

TO PLAY COMPACT DISCS

TO PLAY

- ▶ Insert a CD with the label side up. (The disc will be drawn in and the CD-IN and play indicator will appear on the display.)

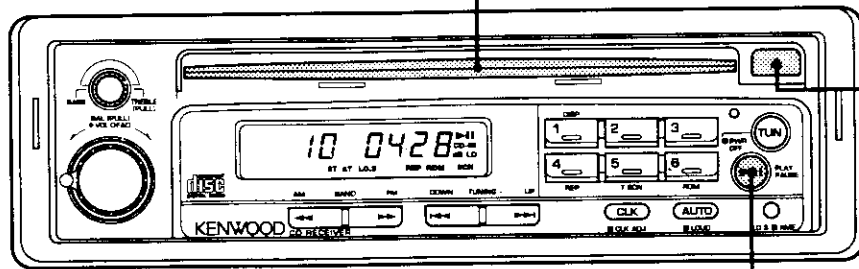
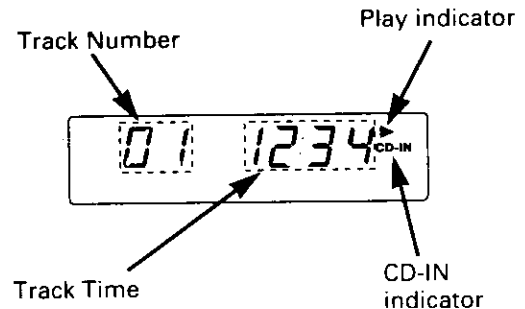
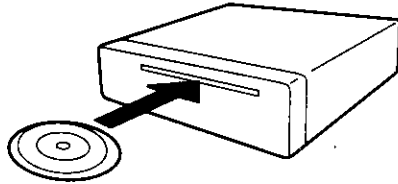

TO PAUSE

- ▶ Press the Play/Pause button. (The Pause indicator will appear on the display.)
- ▶ To restart play, press the Play/Pause button again.

Pause indicator

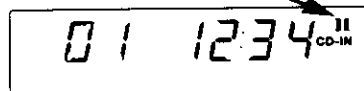

TO STOP AND EJECT

- ▶ Press the Eject button. (The player will eject the disc.)

NOTE

- If you press the Play/Pause button before a disc that has been ejected is removed from the disc slot, it will be drawn back into the player and played, automatically.
- To protect your discs, the player automatically draws in any disc that has been ejected but not removed within 15 seconds.
- Do not attempt to insert a disc in a slot where there is already another disc.

SKIP AHEAD/SKIP BACK

Operation	Press
Skip Ahead	▶▶
Skip Back	◀◀

The action will stop when you release the button.

TIME DISPLAY

- ▶ Each time you press the Display button, the display switches between current track and total CD playback time. (The "+" indicates total CD playback time.)

02 0 123^{CD-IN}

Current track playback time display

02 ÷ 1234^{CD-IN}

Total CD playback time display

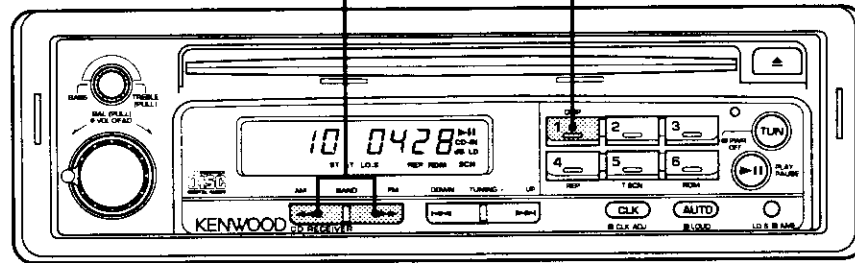

▲ CAUTION

- This unit is designed for playing 12cm (5in.) compact discs. Attempting to play 8cm(3in.) discs may damage the unit and should be avoided.

PRESET STATIONS

1

Select the band and station you want to preset.

2

▶ Press the Preset station button you want to use for more than two seconds.

(When the station is entered in memory, the number of the button to which you've assigned it will appear on the display.)

F 1 9 2 1 - 5

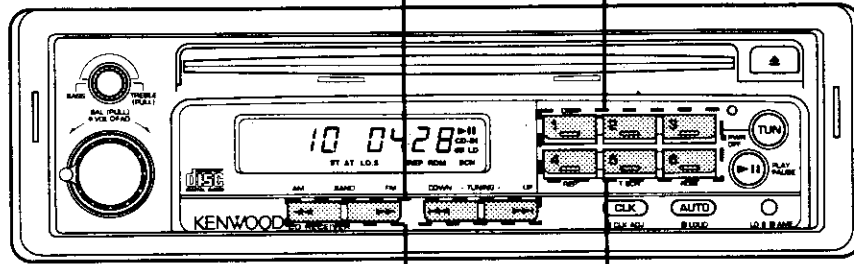

3

By repeating steps 1 and 2 you can preset each button for one station each from the FM1, FM2 and AM bands.

4 USING PRESET STATIONS

▶ Briefly press the button of the station you want.
(When you press the button, you will hear the station assigned to it.)

F 1 9 2 1 - 5

NOTE

- When you assign a preset station to a button, the previous setting will be erased.

1**To select an FM band**

- ▶ Press the FM button to choose FM1 or FM2 .

To select an AM band

- ▶ Press the AM button .

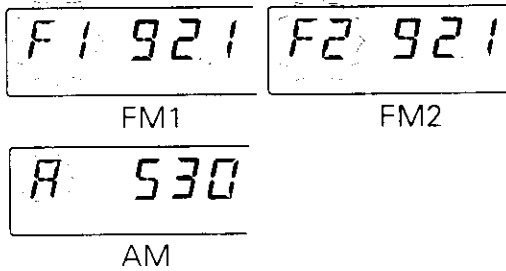
**2**

- ▶ Press the Auto memory button for more than two seconds.

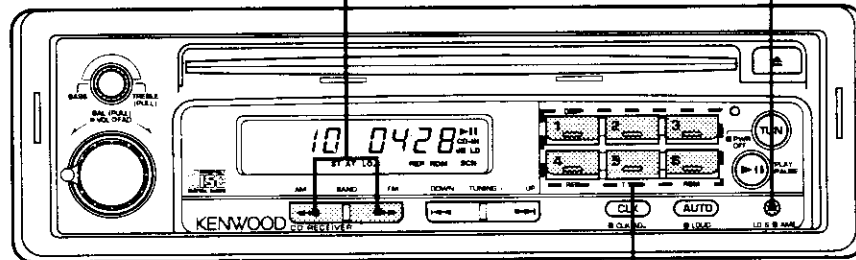
**3**

When six stations have been found, the Auto memory function stops. You will hear the last station selected.

4 USING PRESET STATIONS

- ▶ Briefly press the button of the station you want. (When you press the button, you will hear the station assigned to it.)

TRACK SEARCH

BACKWARD TRACK SEARCH

- ▶ Briefly press the **⏮** button until you see the number of the track you want to play. The unit will begin playing the track shown on the display.



Track No.

FORWARD TRACK SEARCH

- ▶ Briefly press the **⏭** button until you see the number of the track you want to play. The unit will begin playing the track shown on the display.

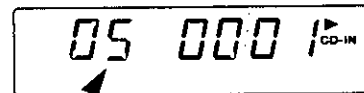

Track No.

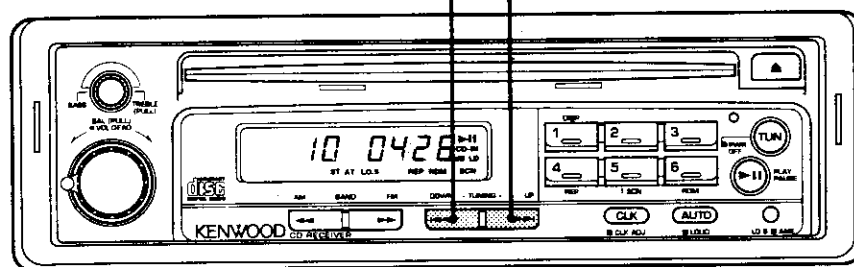

1

- ▶ To repeat the track you are listening to, press the Track repeat button.
(The Repeat indicator will appear on the display.)

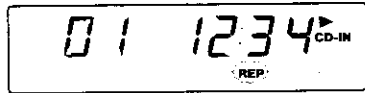

ON

2

The player will repeat the track you are playing.

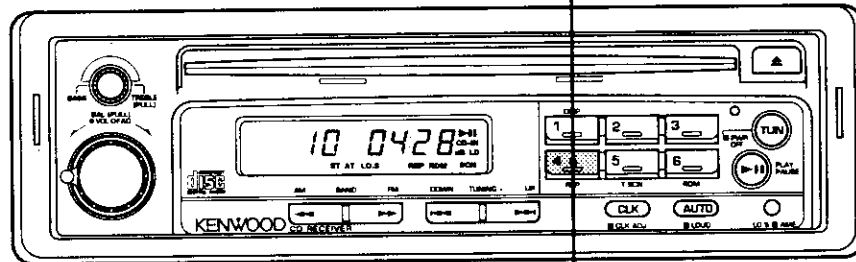

TO STOP

- ▶ Press the Track repeat button again.
(The Repeat indicator will disappear.)

TRACK SCAN

1

- ▶ Press the Track scan button. (The Track scan indicator will light up.)

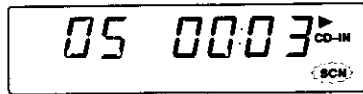

ON

2

- The player will play the first 10 seconds of each track. The track number will flash on the display.

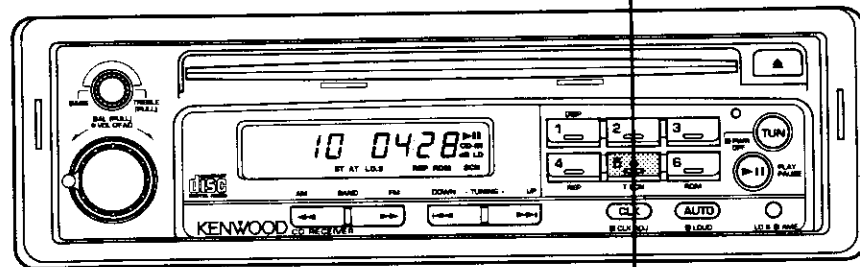

3

- ▶ To select a track, press the Track scan button again. (Scanning will stop and playback begin.)

1

▶ Press the Random button.
(The Random indicator will light up, and the player will randomly select another track from the disc you are playing. The track numbers on the display will change continuously.)

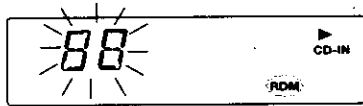

During random search

2

When the track is selected, playback will begin automatically.

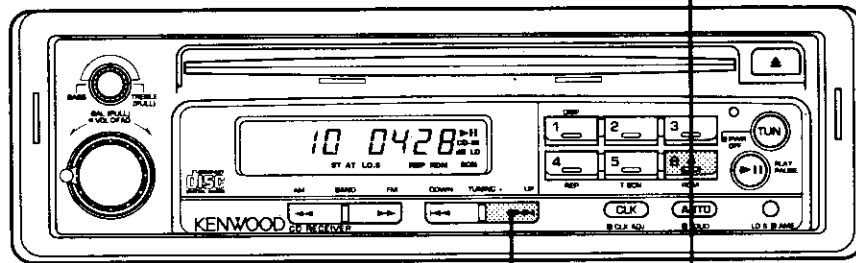

3 TO SELECT ANOTHER TRACK

▶ Press the ►► button.
(The player will randomly choose another track.)

TO STOP

▶ Press the Random button again.
(The disc play returns to normal.)

CLOCK DISPLAYS/SETTING

■ Displays change like this

- ▶ Pressing the Clock button changes displays as indicated to the right.

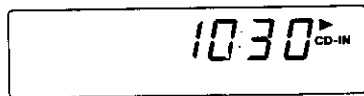

Clock indication

Time	Displays
Tuner	Frequency ↔ Time
CD	Track Number / Track Time ↔ Time

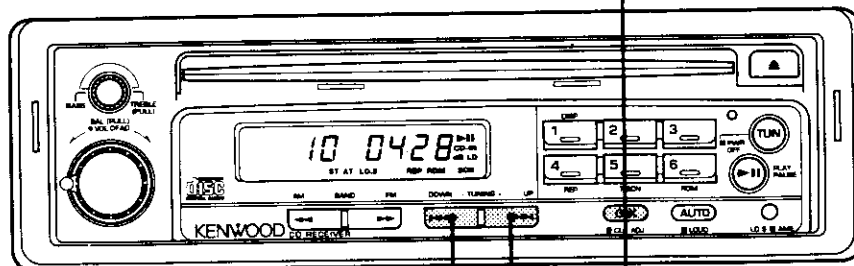

■ To set the clock

1

- ▶ If the time is not being displayed, press the Clock button.

2

- ▶ While holding down the Clock button, press **◀◀** to change the hour and **▶▶** to change the minute.

CHANNEL BAND SELECTION

1

Turn power OFF.

2

- ▶ Hold down preset station buttons "1" and "5".
- ▶ Turn power ON.
(The bands will change to 50kHz for FM and 9kHz for AM.)

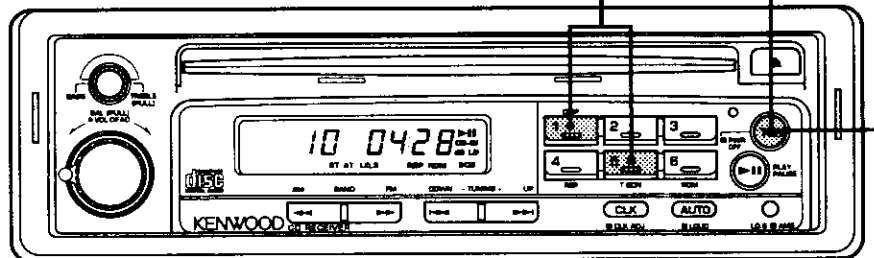



3

Repeating steps 1 and 2 will change the bands back to 200kHz for FM and 10kHz for AM.

NOTE

- When the bands are changed, all memory settings will be erased.
- This feature is not used in the United States and Canada.

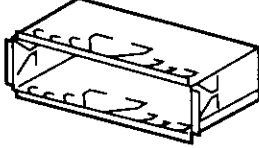
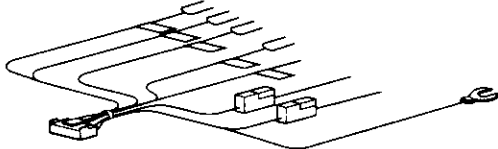
ACCESSORIES

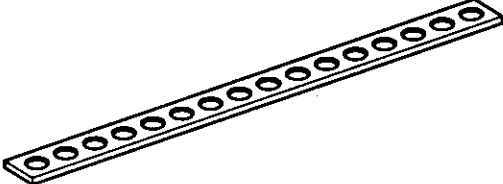
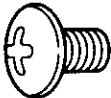
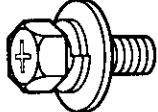
Part Name	External View	Number of Items
Mounting case		1
Wiring harness		1
Removal tool		1
Metal mounting strap		1
Machine screw (M5×6)		4
Assembly screw with washer (M4×8)		1

INSTALLATION PROCEDURE

1. Before starting installation, disconnect the negative (-) terminal of the battery. This will prevent short circuits.
2. Connect the Input and Output leads (p.26).
3. Connect the Ground lead (Black) to the metal body of the car.(p.26).
4. Connect the Memory backup lead (Yellow) (p.26).
5. Connect the Power supply lead (Red) (p.26).
6. Install the unit in the car (p.27).
7. Connect the negative (-) terminal of the battery.
8. Press the Reset button.

▲ CAUTION

- A short circuit may cause a blown fuse. A short circuit is a serious problem that could also cause a fire. Check the wiring carefully and, if any wires are short-circuited, rewire immediately. If no short-circuits are found, replace the fuse with one having the same rating (see indication in fuse box).
- Check that no unconnected wires or connectors are in contact with the body of the car. Extraneous noise or current entering the system can cause malfunction or damage.
- To provide more power, this product is equipped with a BTL (Balanced Transformer Less) system. But in this type of system, sharing different speaker terminals or connecting or grounding speaker terminals to the car can cause distortion or damage.
- Please check that all electrical equipment in the car functions normally after installing the unit.

■ Installation Angle

This unit must be installed at an angle of less than 30° from the horizontal.

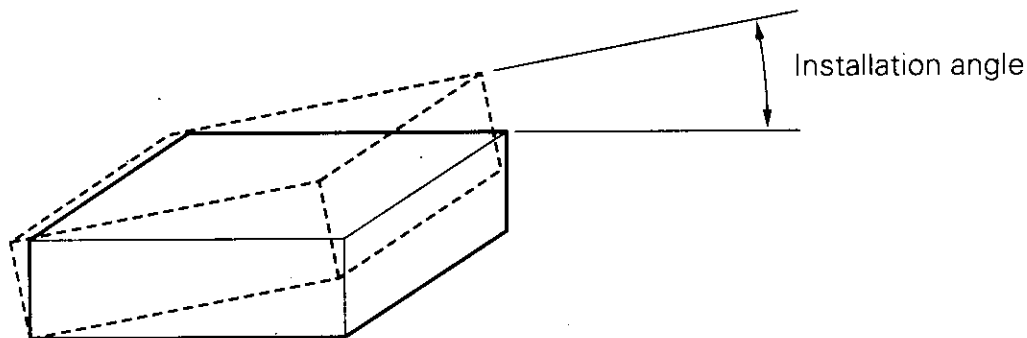

■ Speaker output selector switch.

Set the selector switch on the side plate according to the speaker system used.

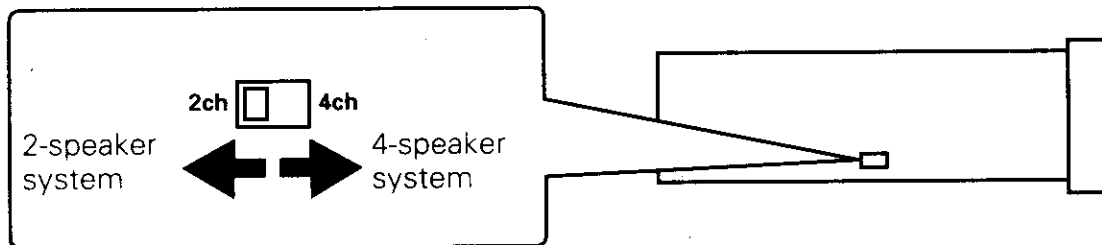

CONNECTIONS

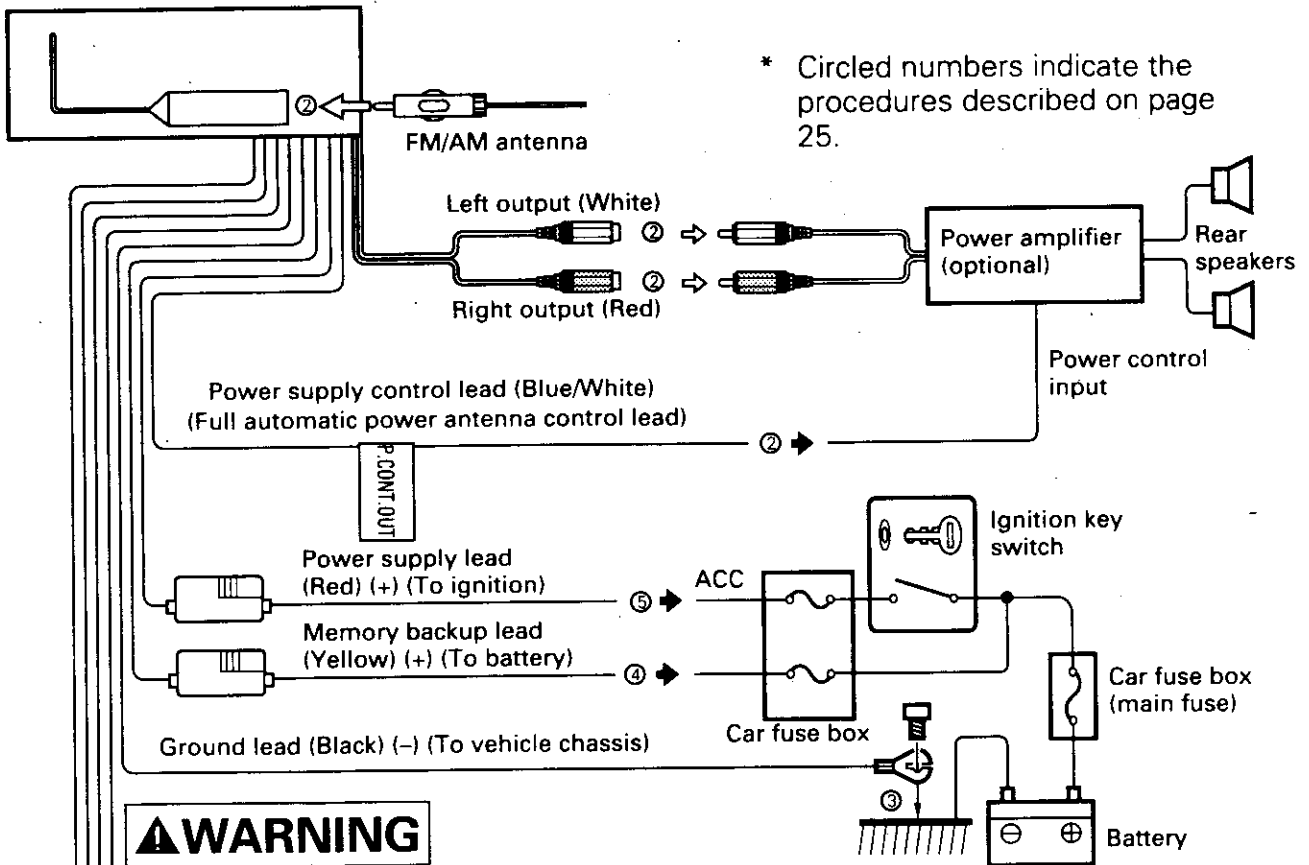

⚠ WARNING

- To prevent fires when the Power Supply lead (Red) and the Memory Backup (Yellow) lead are short-circuited by coming into contact with the vehicle chassis (ground), only connect the power supply after making the fuse box connections first.

⚠ CAUTION

- When two speakers are connected to the system be sure to connect them as indicated below. Any other connection will cause sound distortion and damage to the speakers.

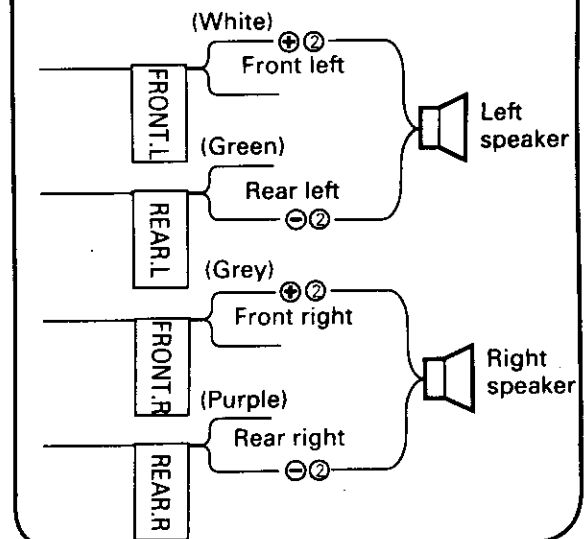
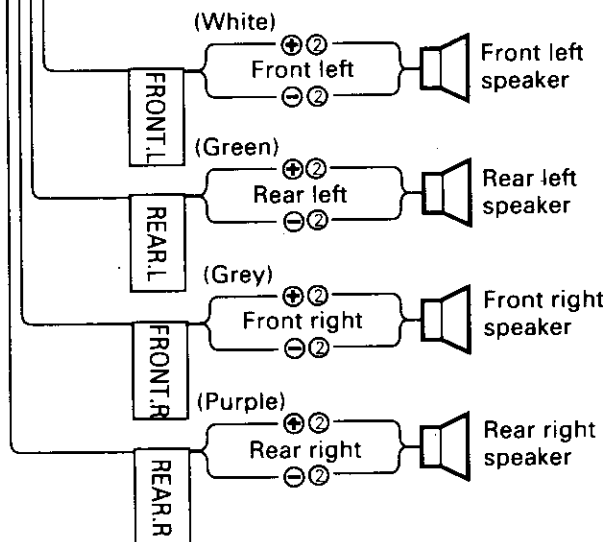

INSTALLATION

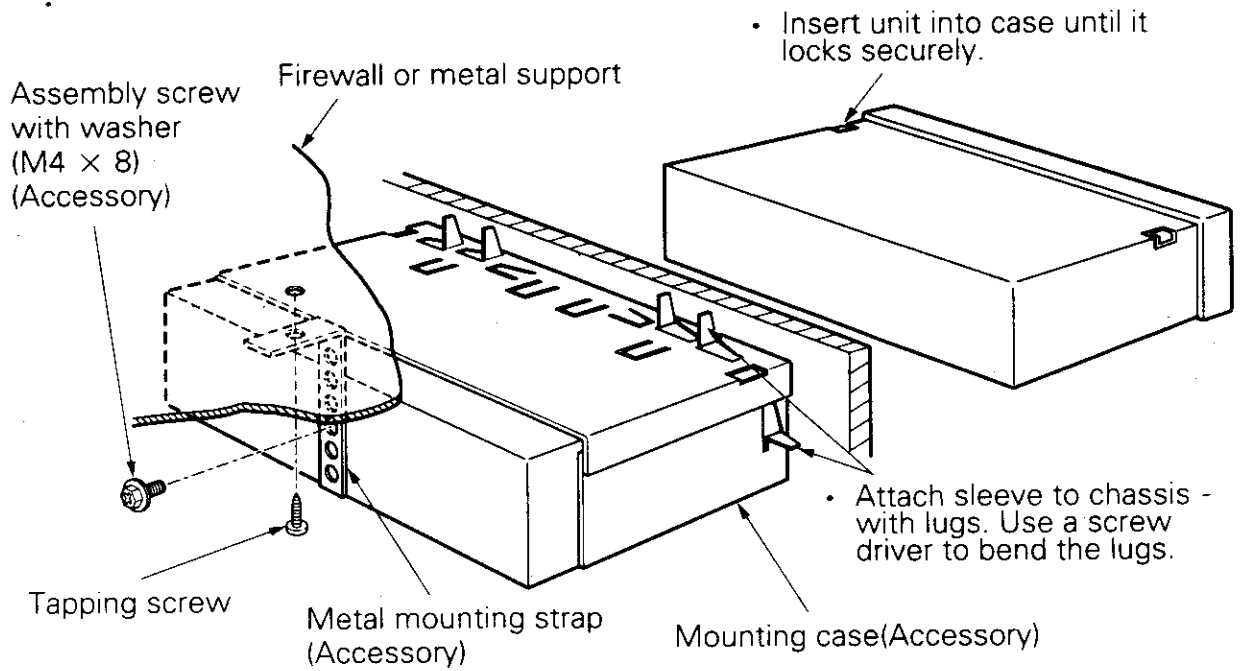

- When installing in some cars made in Japan, insert Machine screws (M5) into 2 of the holes indicated below.

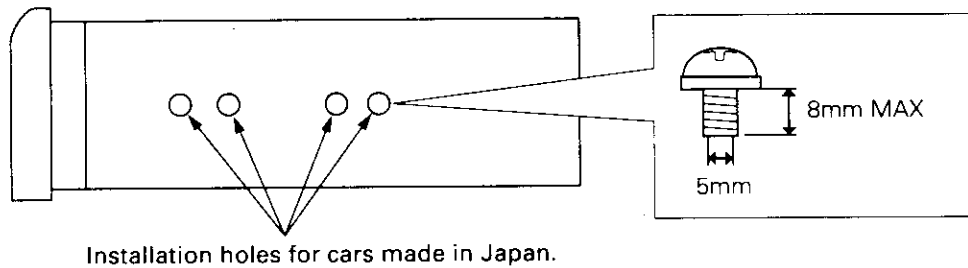

INSTALLATION

■ To remove the unit

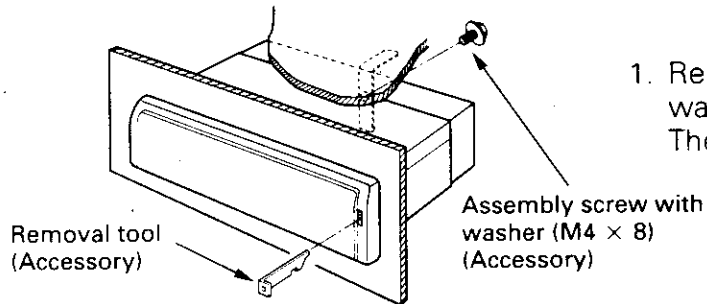

1. Remove the assembly screw with washer holding on the back panel. Then insert removal tool into slot.

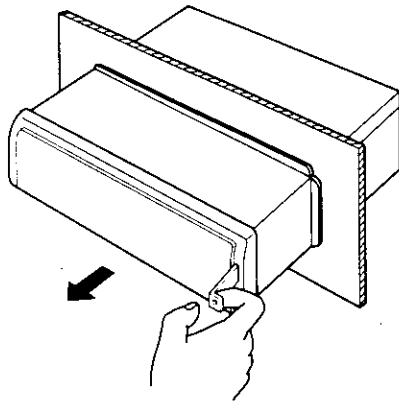

2. Use the removal tool to pull out the unit.

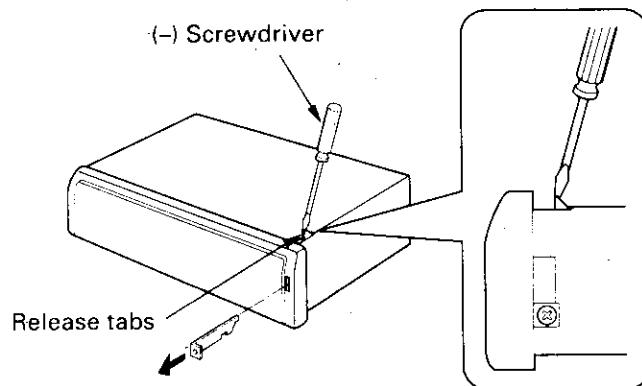

3. While using a screwdriver to press down the release tabs on the side of the chassis, pull out the removal tool.

TROUBLESHOOTING GUIDE

Often, what appears to be a malfunction is due to user error. Before calling for service, please consult the following table.

Symptom	Cause	Remedy
A disc cannot be inserted.	Another disc has already been inserted.	Eject previous disc before inserting another.
A disc is ejected immediately after being inserted.	<ol style="list-style-type: none"> 1. The disc is inserted upside down. 2. The disc is very dirty. 	<ol style="list-style-type: none"> 1. Insert disc with labeled side up. 2. Clean the disc, then reinsert. (See "Cleaning Your Discs.")
The specified track is not played.	The player is set to RANDOM PLAY.	Turn off RANDOM PLAY.
As disc plays, you hear skipping.	The disc is dirty or damaged.	Check and, if possible, clean the disc. (See "Cleaning Your Discs.")
As a disc plays, you hear noise.	<ol style="list-style-type: none"> 1. The disc is dirty or damaged. 2. The recording is poor. 	<ol style="list-style-type: none"> 1. Clean the disc. (See "Cleaning Your Discs.") 2. Try playing another disc. If the sound is good, the fault was with the original disc.
No sound from one channel.	The balance/fader control is turned all the way to one side.	Adjust the balance/fader control.
Poor reception.	The antenna is not extended.	Extend the antenna.
Controls do not function properly.	A power surge has caused the problem.	Press the Reset button on the front panel.

SPECIFICATIONS

Specifications subject to change without notice.

Disc Section

Laser Diode	GaAlAs ($\lambda=780$ nm)
Digital Filter (D/A)	8 Times Over Sampling
D/A Converter	1 bit (with D.P.A.C)
Spindle Speed	500~200 rpm (CLV)
Wow & Flutter	Below Measurable Limit
Frequency Response (± 1 dB)	10 Hz~20 kHz
Total Harmonic Distortion (1 kHz)	0.01 %
Signal to Noise Ratio	93 dB
Dynamic Range	96 dB
Channel Separation	85 dB

FM Tuner Section

Frequency Range (200 kHz space)	87.9 MHz~107.9 MHz
(50 kHz space)	87.5 MHz~108.0 MHz
Usable Sensitivity	12.0 dBf (1.1 μ V/75 Ω)
50 dB Quieting Sensitivity	15.2 dBf(1.6 μ V/75 Ω)
Frequency Response (± 1 dB)	30 Hz~15 kHz
Signal to Noise Ratio (IEC-A)	73 dB
Selectivity (DIN)	70 dB
Capture Ratio	1.5 dB
Stereo Separation (1 kHz)	40 dB

AM Tuner Section

Frequency Range (10 kHz space)	530 kHz~1,700 kHz
(9 kHz space)	531 kHz~1,611 kHz
Usable Sensitivity	27 dB μ

Audio Section

Max. Power Output	25 W \times 2 or 9 W \times 4
Power Output (4 Ω , 30 Hz~20 kHz, 1% THD)	15 W \times 2 or 6 W \times 4
Tone Action	Bass: 100 Hz \pm 8 dB Treble: 10 kHz \pm 8 dB
Preout Level (10 k Ω)	1.0 V

General

Operating Voltage	14.4 V (11~16 V)
Current Consumption	5.0 A
Operating Temperature	-10~50 $^{\circ}$ C
Installation Size (W \times H \times D)	182 \times 52 \times 158 mm (7-3/16 \times 2-1/16 \times 6-1/4 in.)
Weight	1.8 kg (4.0 lb)